

# Latigo

## Egg Chair

style # FRS50006H-1

dpci # 009000798

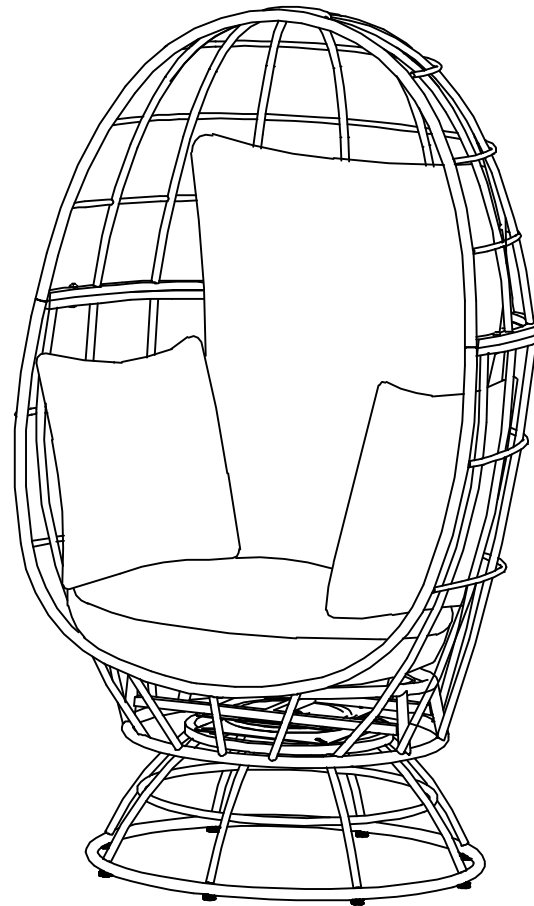

>>assembly instructions



## **Congratulations on your latest Target purchase.**

Now what? Don't start sweating over this box of parts. This will be easy. We did the hard work for you. All you need to do is follow our simple instructions and you'll be on your way to transforming your patio in no time. Good luck – though we're confident you won't need it.

## **IMPORTANT WARNING:**

Unpack the box on a clean, soft, level surface and make sure all parts have been included. To replace missing or damaged parts please call 855-MYTGTHOME (855-698-4846) during 7am - 7pm CST M-F, and 8am - 5pm CST Saturday.

## **ATTENTION:**

This Chair is not intended for use during any kind of inclement weather and the manufacturer is not, and can not be held responsible for any damages caused as a result of such weather. Weather-related damage, or damage as a result of the Chair not being stored properly when not in use, is not the responsibility of the manufacturer.

During extended periods of non-usage, off season, or in inclement weather (wind, rain, snow, hail, sleet), freezing conditions and extreme heat, the Chair needs to be stored in a dry, sheltered place to prolong the life and to avoid damage to the Chair.

## **WARRANTY:**

This Chair comes with a one year limited warranty against original manufacture defects. If you experience trouble with your chair, please call the customer service number below.

Target Corporation

Toll Free at: 855-MYTGTHOME (855-698-4846) during 7am - 7pm CST M-F, and 8am - 5pm CST Saturday.

Code: Yotrio 2019

## **before you begin**

1. Check for damage or missing parts. Call 855-MYTGTHOME (855-698-4846) to order missing supplies.
2. Use the carton as a working surface to prevent product damage during assembly.
3. Gather all tools prior to assembly.

## table of contents

---

introduction	2-3
hardware	5
parts list	6
assembly	7-10

# hardware

---

**(Part D)×7**  
M6 nut



**(Part E)×4**  
spring washer



**(Part F)×7**  
washer



**(Part G)×3**  
M6\*45 bolt with washer

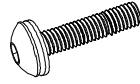

**(Part H)×4**  
M6\*30 flat bolt with washer

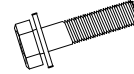

**(Part I)×2**  
Connecting

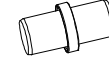

**(Part J)×2**  
hex wrench

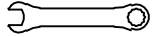

**(Part K)×1**  
allen wrench



ITEM DESCRIPTION QUANTITY

---

A back frame 1  
B seat frame 1  
C leg frame 1

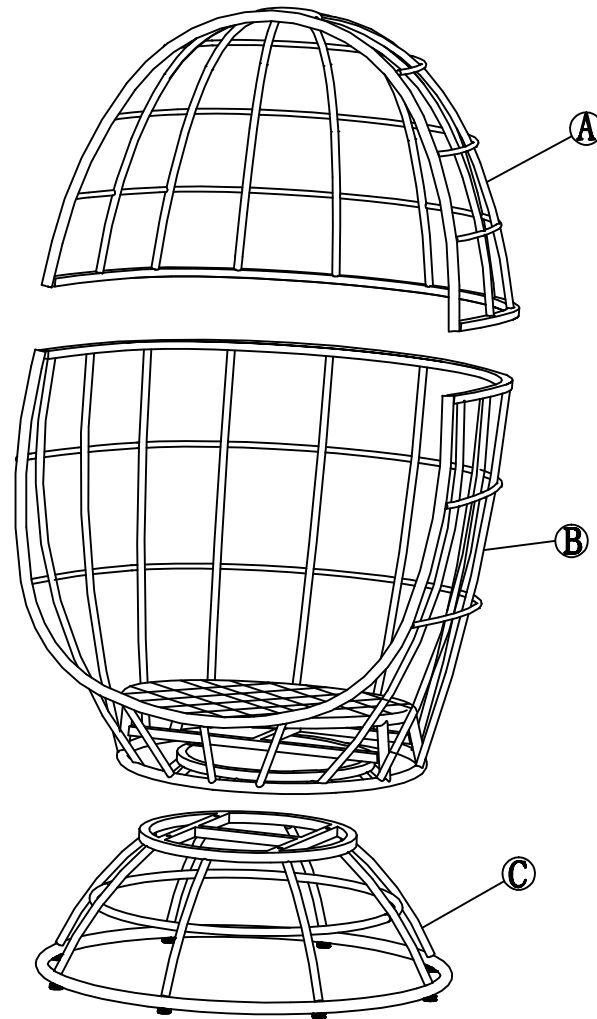

# step 01:

---

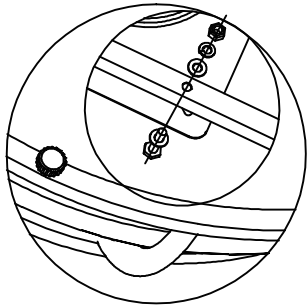

(Part D)×7  
M6 nut



(Part E)×4  
spring washer



(Part F)×7  
washer



(Part G)×3  
M6\*45 bolt with washer

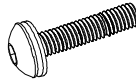

(Part H)×4  
M6\*30 flat bolt with washer

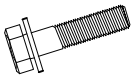

(Part I)×2  
Connecting

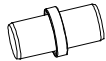

(Part J)×2  
hex wrench

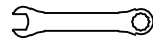

(Part K)×1  
allen wrench

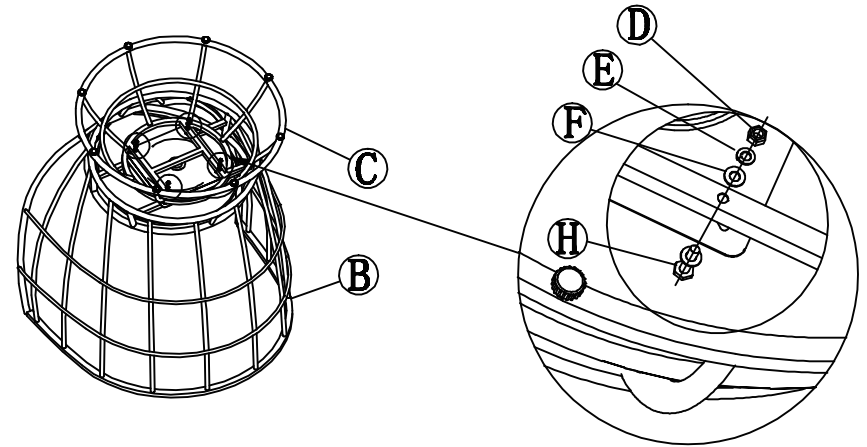

**ATTENTION:** To avoid damage to your new patio furniture, please use either the carton or another soft surface such as carpet as a working surface to prevent product damage during assembly.

1. Place the seat frame (B) upside down on a soft surface such as carpet.
2. Attach the leg frame (C) to the seat frame (B) by lining up screw holes on the seat frame (B) with corresponding screw holes on the leg frame (C).
3. Secure with M6\*30 flat bolt with washer (H) washer (F), spring washer (E) and M6 nut (D). tighten using allen wrench (K) and hex wrench(J).

## step 02:

---

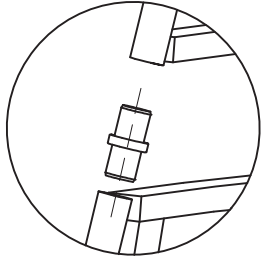

(Part D)×7  
M6 nut



(Part E)×4  
spring washer



(Part F)×7  
washer



(Part G)×3  
M6×45 bolt with washer

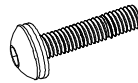

(Part H)×4  
M6×30 flat bolt with washer

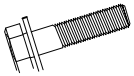

(Part I)×2  
Connecting

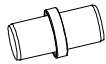

(Part J)×2  
hex wrench

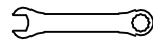

(Part K)×1  
allen wrench

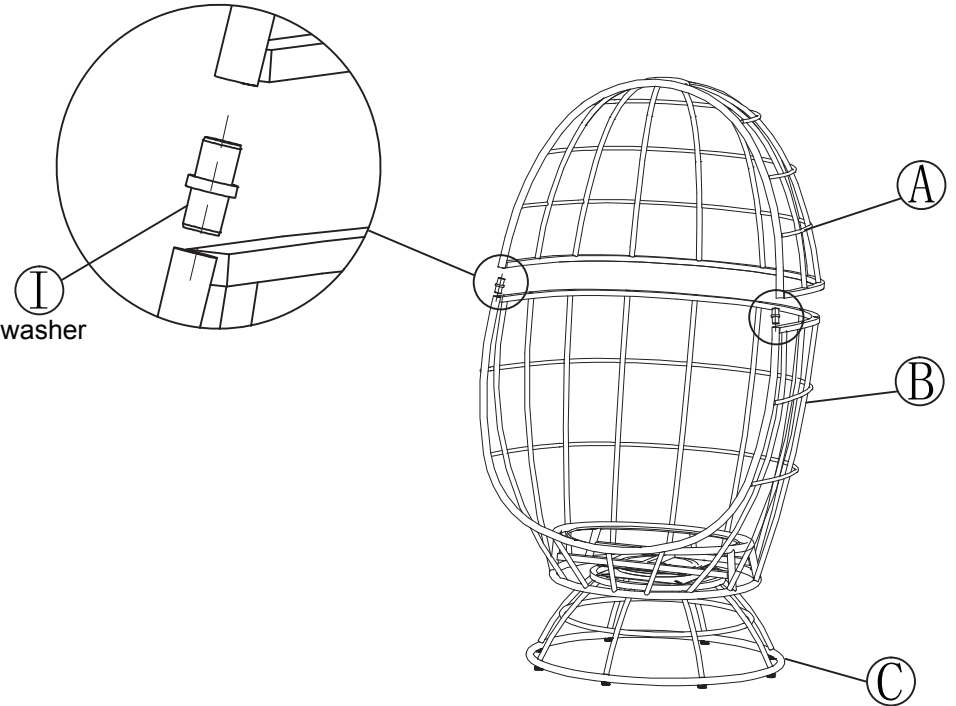

**ATTENTION:** To avoid damage to your new patio furniture, please use either the carton or another soft surface such as carpet as a working surface to prevent product damage during assembly.

1. Place the leg frame (C) and seat frame (B) right side up on a soft surface such as carpet.
2. Attach the back frame (A) to the seat frame (B) and leg frame (C) by lining up screw holes on the seat frame (B) with corresponding screw holes on the back frame (A).
3. Insert the connecting (I) into the upper and lower tube.



## step 03:

---

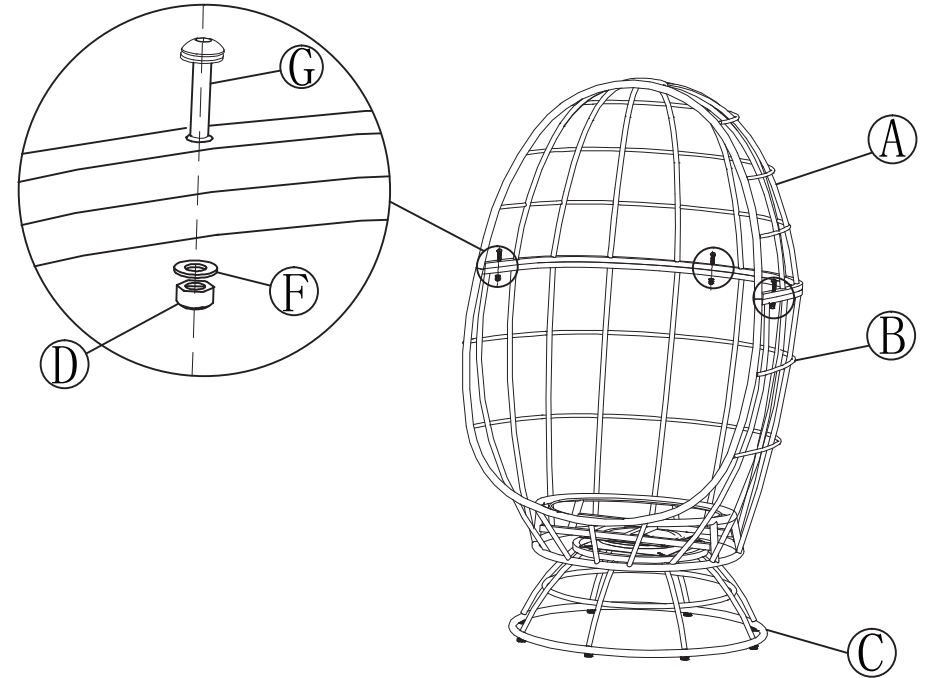
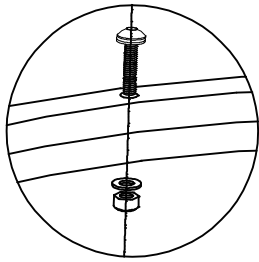

(Part D)×7  
M6 nut



(Part E)×4  
spring washer



(Part F)×7  
washer



(Part G)×3  
M6\*45 bolt with washer

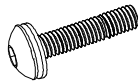

(Part H)×4  
M6\*30 flat bolt with washer

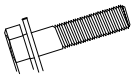

(Part I)×2  
Connecting

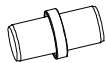

(Part J)×2  
hex wrench

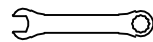

(Part K)×1  
allen wrench



**ATTENTION:** To avoid damage to your new patio furniture, please use either the carton or another soft surface such as carpet as a working surface to prevent product damage during assembly.

1. Attach the back frame (A) to the seat frame (B) and leg frame (C) by lining up screw holes on the seat frame (B) with corresponding screw holes on the back frame (A).
3. Secure with M6\*45 bolt with washer(G), washer (F) and M6 nut (D). tighten using allen wrench (K) and hex wrench (J).

## step 04:

---

- 
1. Tighten all the screws.
  2. Turn the chair to upright position on a flat level surface.  
Put the cushion on the chair.

You are now ready to enjoy your new chair.

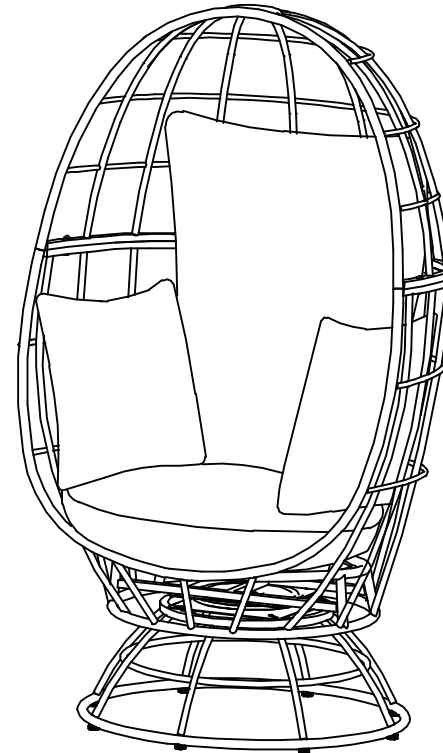

For longer life, cover and store when not in use.

**Frame Care:**

Wipe clean with damp cloth. Use only mild soap and detergents.

**Thank you for making your Patio purchase at Target! Please review your purchase on Target.com.**

