

halsted

steel wicker club chair

style # FRS80712GST3

dpci # 009008273

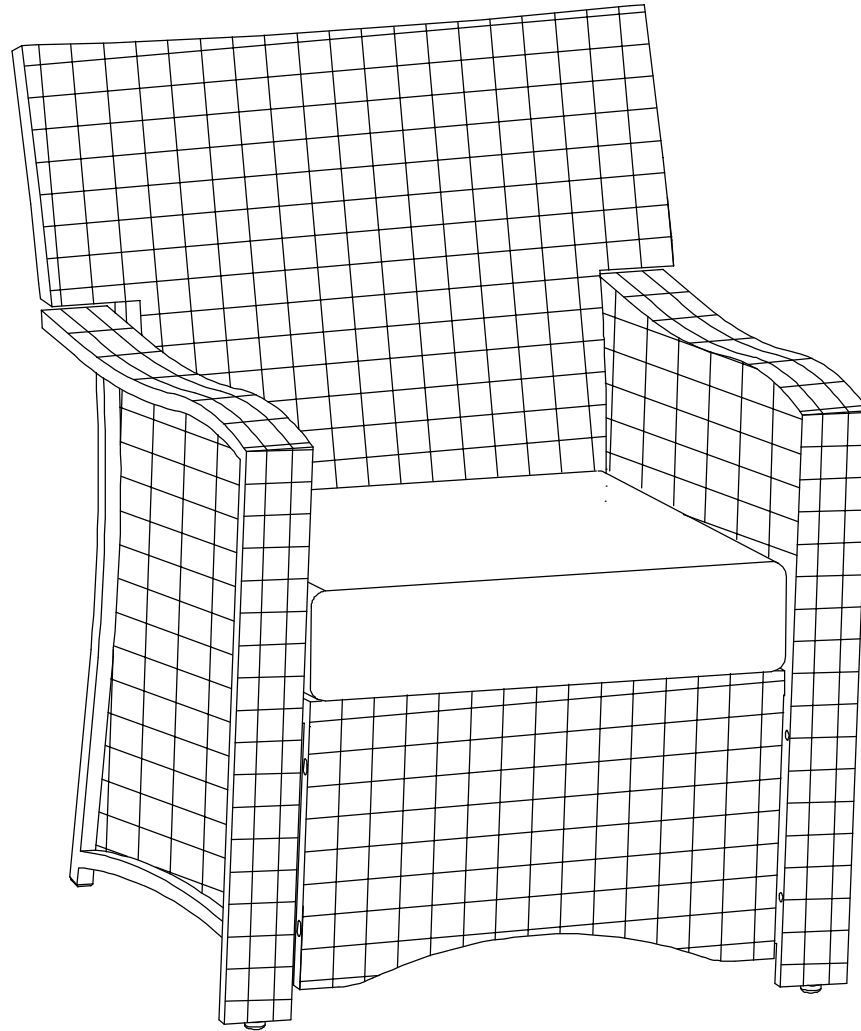

>>assembly instructions



Congratulations on your latest Target purchase.

Now what? Don't start sweating over this box of parts. This will be easy. We did the hard work for you. All you need to do is follow our simple instructions and you'll be on your way to transforming your patio in no time. Good luck – though we're confident you won't need it.

IMPORTANT WARNING:

Unpack the box on a clean, soft, level surface and make sure all parts have been included. To replace missing or damaged parts please call 855-MYTGTHOME (855-698-4846) during 7am - 7pm CST M-F, and 8am - 5pm CST Saturday.

ATTENTION:

This Chair is not intended for use during any kind of inclement weather and the manufacturer is not, and can not be, held responsible for any damages caused as a result of such weather. Weather-related damage, or damage as a result of the Chair not being stored properly when not in use, is not the responsibility of the manufacturer.

During extended periods of non-usage, off season, or in inclement weather (wind, rain, snow, hail, sleet), freezing conditions and extreme heat, the Chair needs to be stored in a dry, sheltered place to prolong the life and to avoid damage to the Chair.

WARRANTY:

This Chair comes with a one year limited warranty against original manufacture defects. If you experience trouble with your chair, please call the customer service number below.

Target Corporation

Toll Free at: 855-MYTGTHOME (855-698-4846) during 7am - 7pm CST M-F, and 8am - 5pm CST Saturday.

Code: Yotrio 2018

before you begin

1. Check for damage or missing parts. Call 855-MYTGTHOME (855-698-4846) to order missing supplies.
2. Use the carton as a working surface to prevent product damage during assembly.
3. Gather all tools prior to assembly.

table of contents

introduction	2-3
hardware	5
parts list	6
assembly	7-12

hardware

(Part E)×4
M6*20mm screw



(Part F)×12
M6*40mm screw



(Part G)×4
M6*50mm screw



(Part H)×20
washer



(Part I)×1
allen wrench



ATTENTION: THE HARDWARE KIT IS FOR 2 CHAIRS.

ITEM	DESCRIPTION	QUANTITY
------	-------------	----------

A	right armrest	2
B	left armrest	2
C	chair back	2
D	chair seat	2

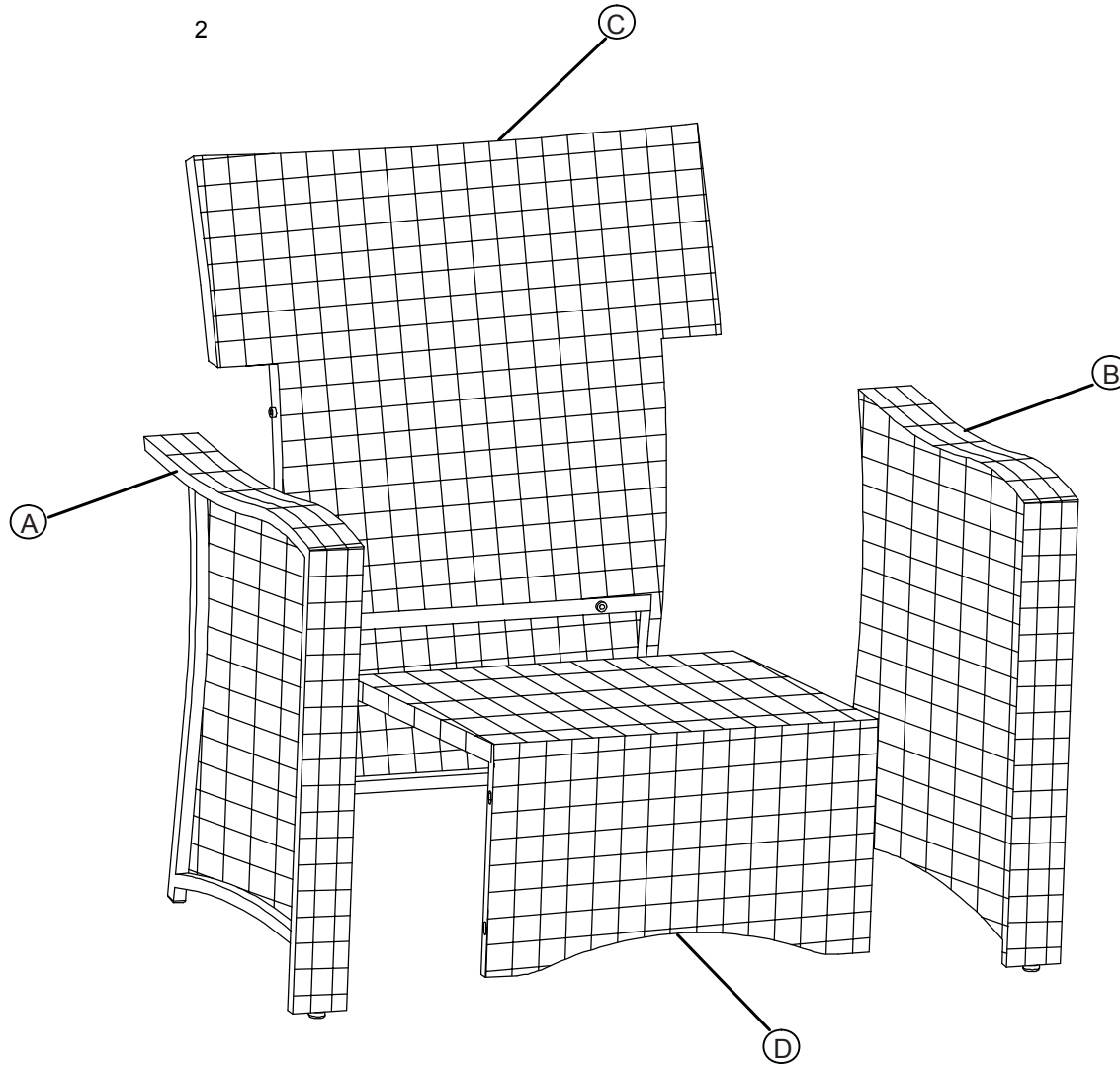

step 01:

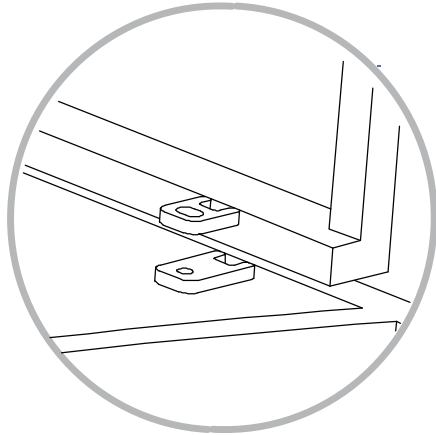

(Part E)×1

M6*20mm screw



(Part H)×1

washer

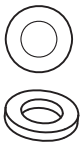

(Part I)×1

allen wrench



ATTENTION: To avoid damage to your new patio furniture, please use either the carton or another soft surface such as carpet as a working surface to prevent product damage during assembly.

1. Attach the right armrest (A) to the back frame (C) by lining up screw holes on the right armrest (A) with corresponding screw holes on the back frame (C).
2. Secure with M6*20mm screw (E) and washer (H) using allen wrench (I).

Do not completely tighten screws until all screws are in place.

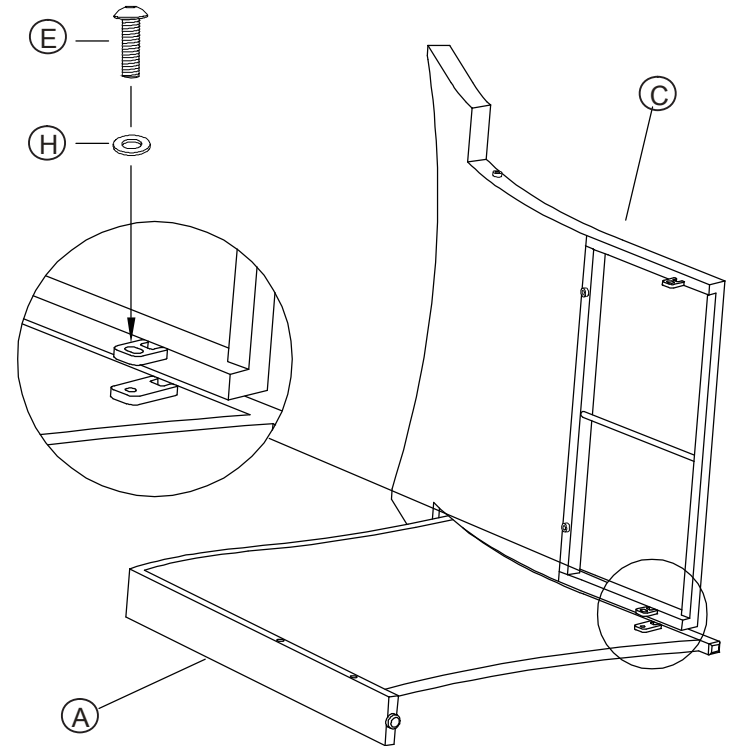

step 02:

1.

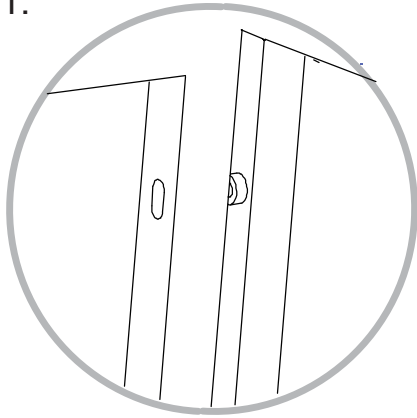

2.

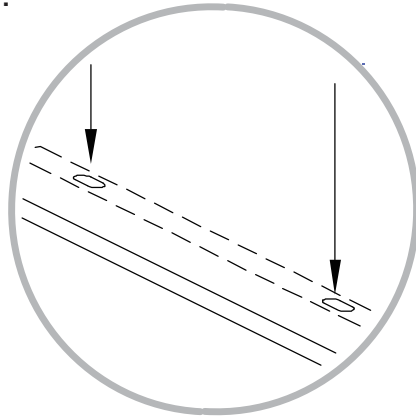

(Part F)×2

M6*40mm screw



(Part G)×2

M6*50mm screw



(Part H)×4

washer



(Part I)×1

allen wrench

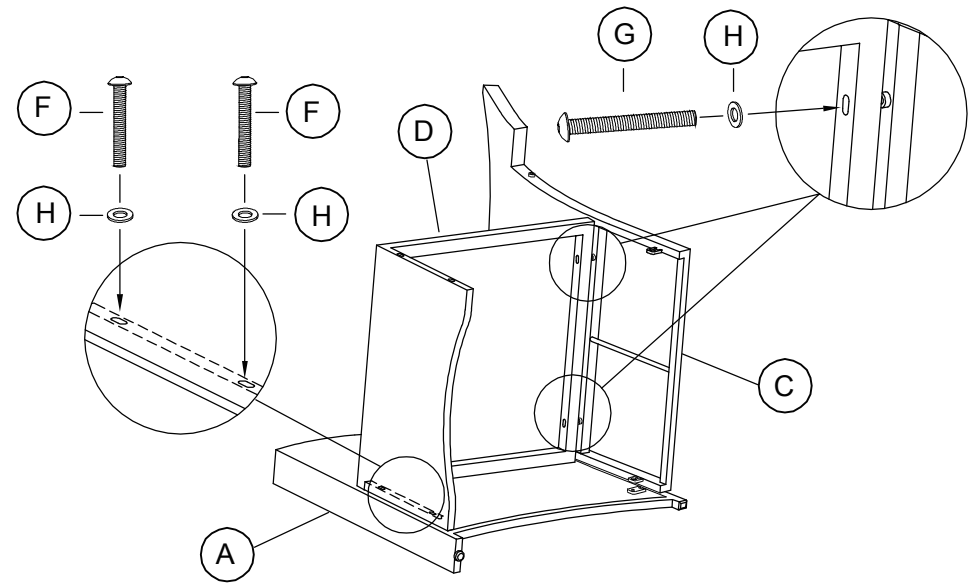

1. Attach the seat frame (D) to the back frame (C) and right armrest (A) by lining up screw holes on the back frame (C) and right armrest (A) with corresponding screw holes on the back frame (C).

2. Secure with M6*40mm screw (F) and washer (H) using allen wrench (I) on the right armrest (A) and seat frame (D).

3. Secure with M6*50mm screw (G) and washer (H) using allen wrench (I) on the back frame (C) and seat frame (D).

Do not completely tighten screws until all screws are in place.

step 03:

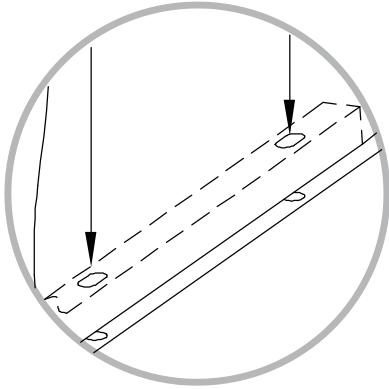

(Part F)×2
M6*40mm screw



(Part H)×2
washer

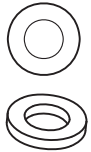

(Part I)×1
allen wrench



1. Attach the left armrest (B) to the seat frame (D) by lining up screw holes on the left armrest (B) with corresponding screw holes on the seat frame (D).
2. Secure with M6*40mm screw (F) and washer (H) using allen wrench (I).

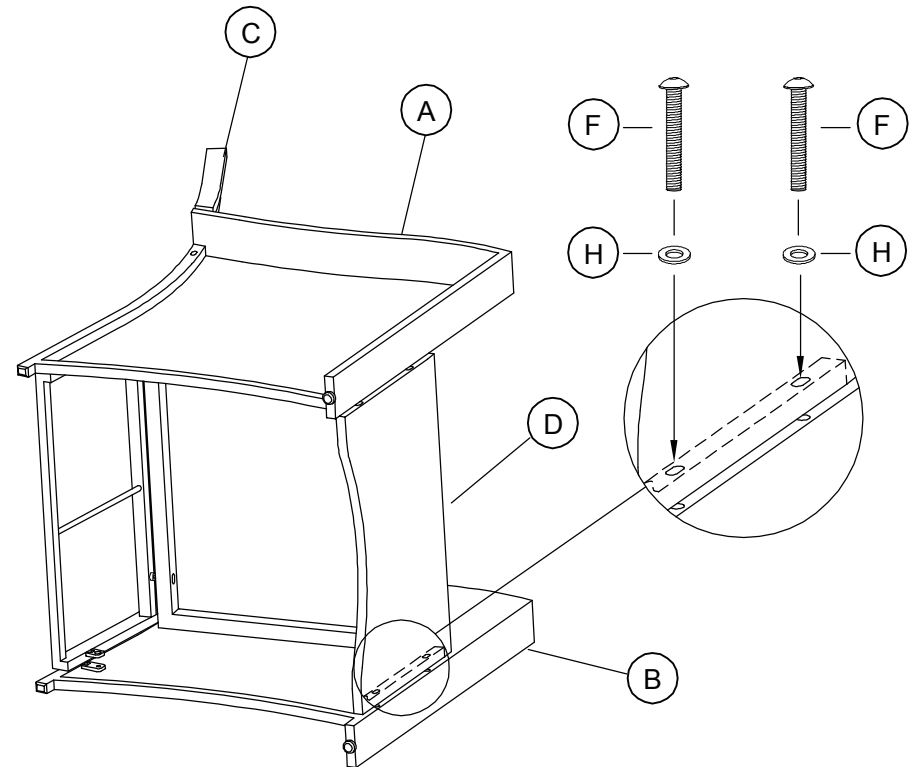

Do not completely tighten screws until all screws are in place.

step 04:

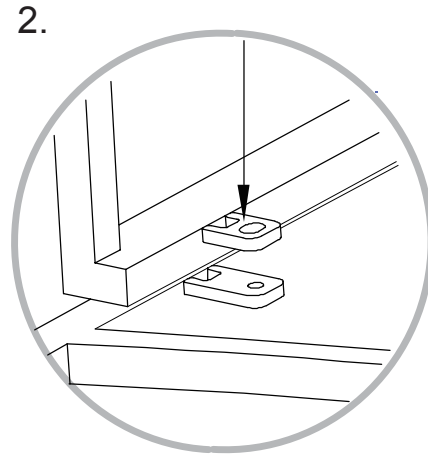
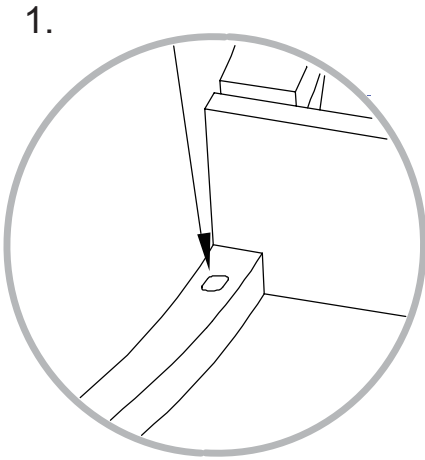

(Part E)×1

M6*20mm screw



(Part F)×1

M6*40mm screw



(Part H)×2

washer



(Part I)×1

allen wrench



1. Secure with M6*40mm screw (F) and washer (H) using allen wrench (I) on the right armrest (A) and back frame (C).

2. Secure with M6*20mm screw (E) and washer (H) using allen wrench (I) on the back frame (C) and left armrest (B).

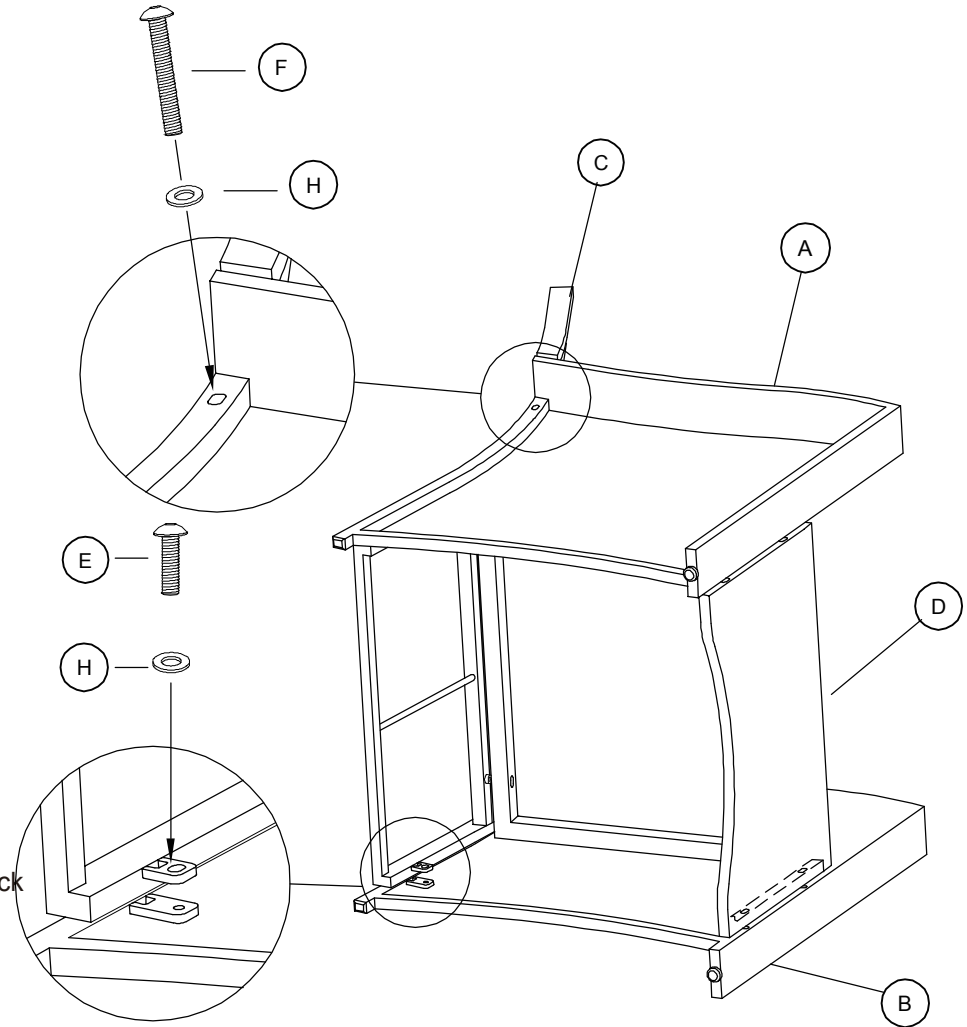

Do not completely tighten screws until all screws are in place.

step 05 :

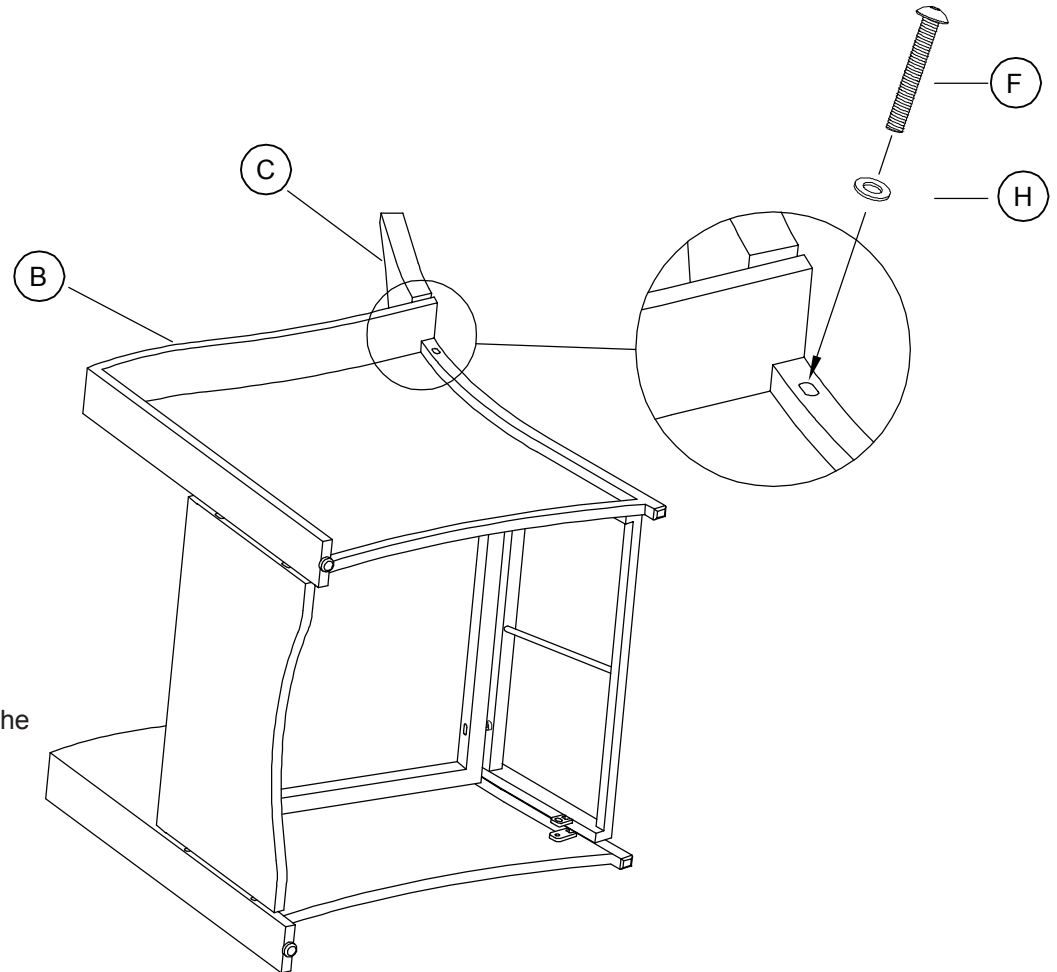
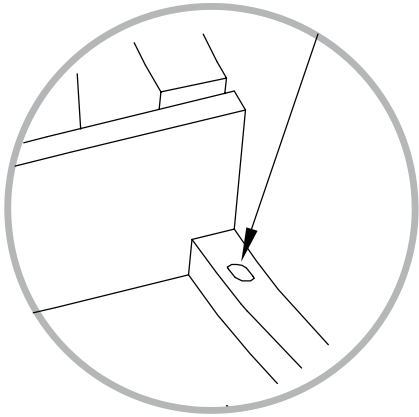

(Part F)x1
M6*40mm screw



(Part H)x1
washer

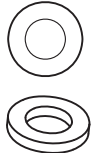

(Part I)x1
allen wrench



1. Secure with M6*40mm screw (F) and washer (H) using allen wrench (I) on the left armrest (B) and back frame (C).

Do not completely tighten screws until all screws are in place.

step 06:

-
1. Tighten all the screws.
 2. Turn the chair to upright position onto a flat, level surface.
Put the cushion on the chair.
 3. Repeat these steps for another chair.

You are now ready to enjoy your new chair.

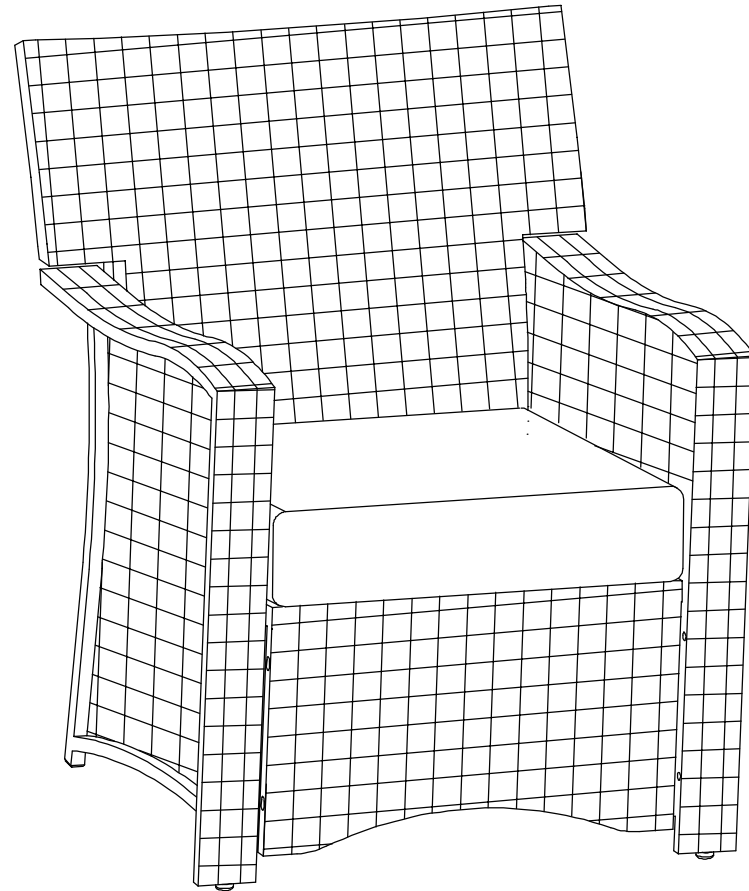

For longer life, cover and store when not in use.

Frame Care:

Wipe clean with damp cloth. Use only mild soap and detergents.

Thank you for making your Patio purchase at Target! Please review your purchase on Target.com.

