

halsted

steel wicker coffee table

style # FRS80712GST4

dpci # 009008274

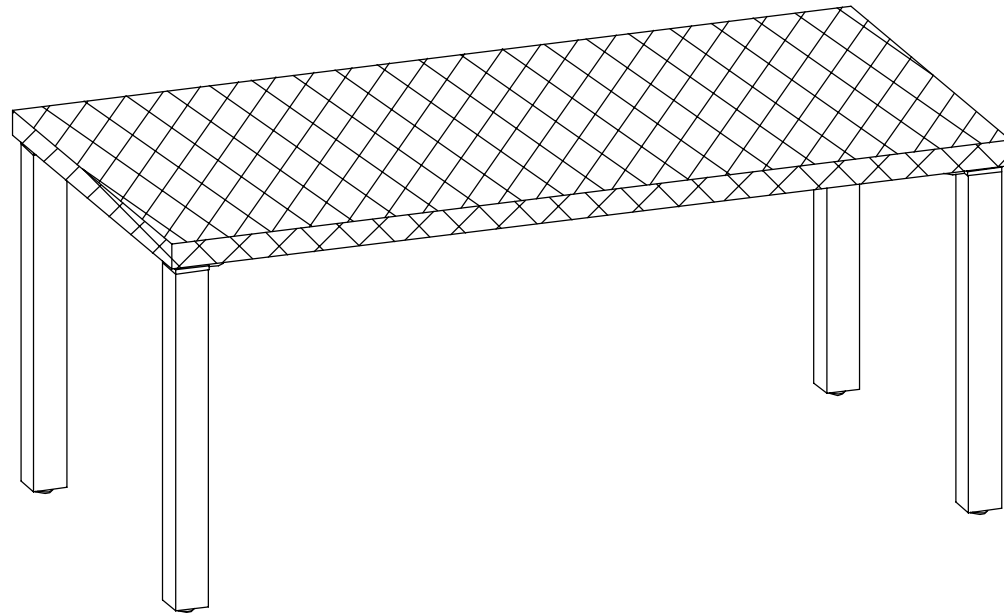

>>assembly instructions



Congratulations on your latest Target purchase.

Now what? Don't start sweating over this box of parts. This will be easy. We did the hard work for you. All you need to do is follow our simple instructions and you'll be on your way to transforming your patio in no time. Good luck – though we're confident you won't need it.

IMPORTANT WARNING:

Unpack the box on a clean, soft, level surface and make sure all parts have been included. To replace missing or damaged parts please call 855-MYTGTHOME (855-698-4846) during 7am - 7pm CST M-F, and 8am - 5pm CST Saturday.

ATTENTION:

This Table is not intended for use during any kind of inclement weather and the manufacturer is not, and can not be, held responsible for any damages caused as a result of such weather. Weather-related damage, or damage as a result of the Table not being stored properly when not in use, is not the responsibility of the manufacturer.

During extended periods of non-usage, off season, or in inclement weather (wind, rain, snow, hail, sleet), freezing conditions and extreme heat, the Table needs to be stored in a dry, sheltered place to prolong the life and to avoid damage to the Table.

WARRANTY:

This Table comes with a one year limited warranty against original manufacture defects. If you experience trouble with your new table, please call the customer service number below.

Target Corporation

Toll Free at: 855-MYTGTHOME (855-698-4846) during 7am - 7pm CST M-F, and 8am - 5pm CST Saturday.

Code: Yotrio 2018

before you begin

1. Check for damage or missing parts. Call 855-MYTGTHOME (855-698-4846) to order missing supplies.
2. Use the carton as a working surface to prevent product damage during assembly.
3. Gather all tools prior to assembly.

table of contents

introduction	2-3
hardware	5
parts list	6
assembly	7-8

hardware

(Part C)×12
M6*15mm screw



(Part D)×12
washer

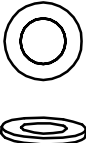

(Part E)×1
allen wrench



ITEM	DESCRIPTION	QUANTITY
------	-------------	----------

A	table top	1
B	table leg	4

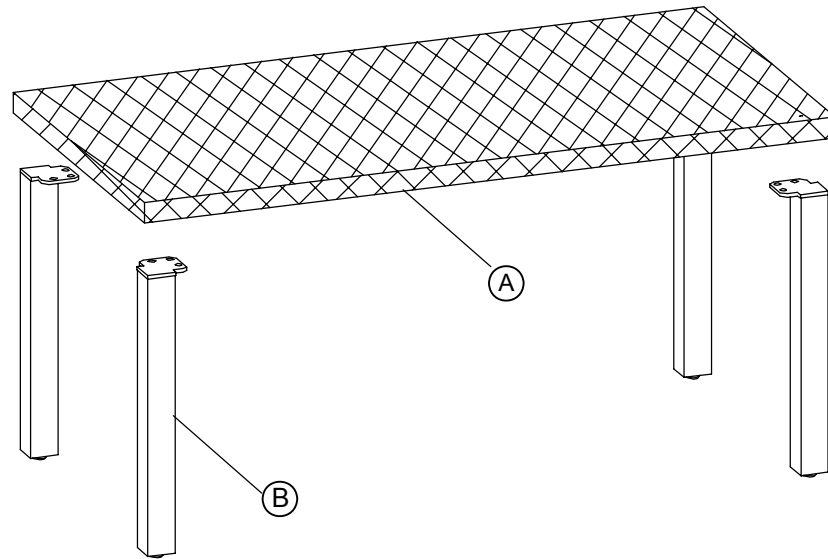

step 01:

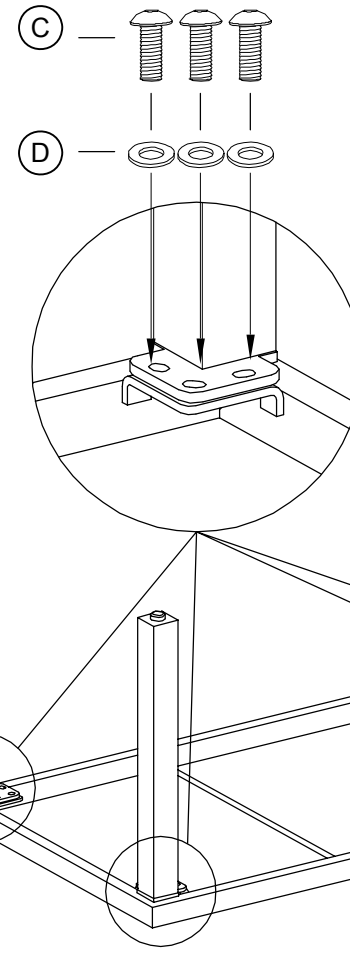
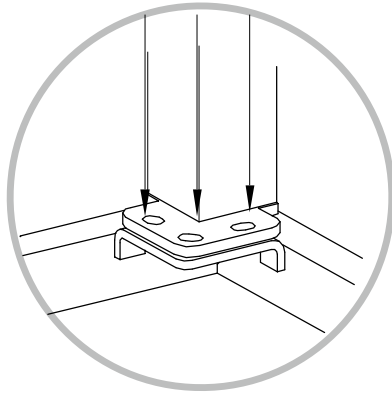

(Part C)×12
M6*15mm screw

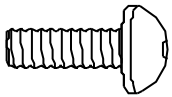

(Part D)×12
washer

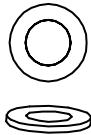

(Part E)×1
allen wrench



ATTENTION: To avoid damage to your new patio furniture, please use either the carton or another soft surface such as carpet as a working surface to prevent product damage during assembly.

1. Line up the bolt holes on the end of the table leg (B) with the corresponding bolt holes on the table top (A). Secure with M6*15mm screws (C) and washers (D) using allen wrench (E).
2. Repeat above step until the 4 table legs (B) are secured to the table top (A).

Do not completely tighten screws until all screws are in place.

step 02:

.....
1. Tighten all the screws. Set the table in an upright position on a flat level surface.

You are now ready to enjoy your new table.

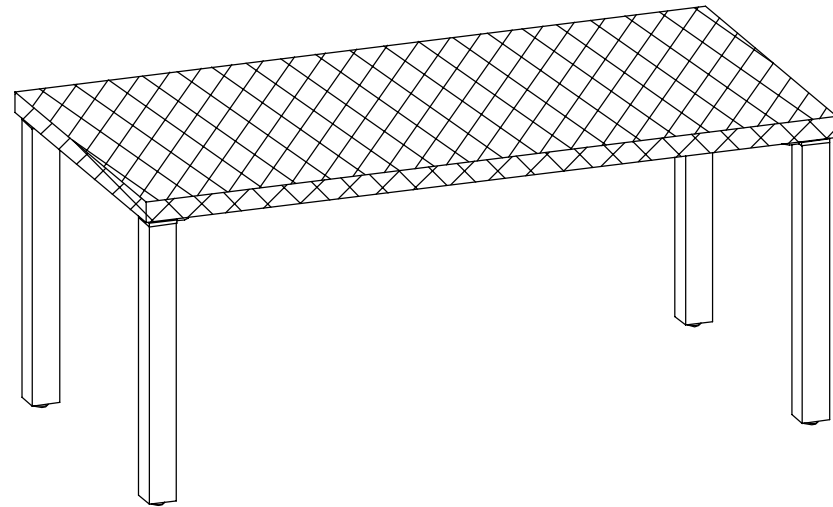

For longer life, cover and store when not in use.

Frame Care:

Wipe clean with damp cloth. Use only mild soap and detergents.

Thank you for making your Patio purchase at Target! Please review your purchase on Target.com.

QUESTIONS? Just call 855-MYTGTHOME (855-698-4846) for parts and service. For faster service, have the style number and DPCI number ready when when calling.

